







-  **rechteckige Putztür, Aussenöffnung**
-  **RECTANGULAR manwaydoor outwards opening**
-  **Porte rectangulaire avec ouverture à l'extérieur**
-  **Puerta rectangular de apertura externa**
-  **PORTELLA RETTANGOLARE apertura esterna**
-  **ПРЯМОУГОЛЬНАЯ КРЫШКА с внешним открытием**





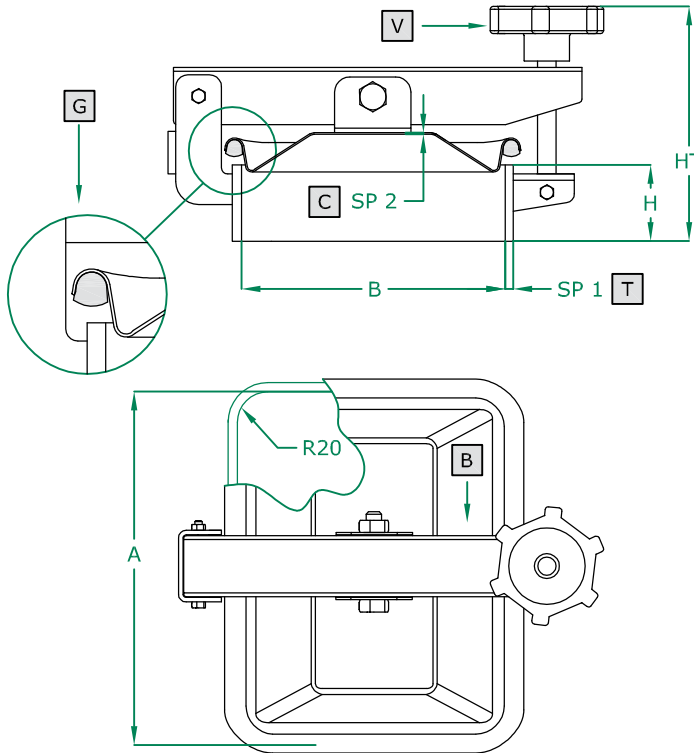

381 ART
225 X 175 mm

Deckel cover	C
Kragen frame	T
Hebelarm lever	B
Handrad handwheel	V
Dichtung gasket	G



	STANDARD		OPTIONAL			
H X SP1	50 X 6	30 X 6	100 X 6			
RAHMEN	SAT		MPL			
DICHTUNG	PARA	EPDM	NEOPRENE	NBR	SILICONE	VITON
HANDRAD	125 001 V	125 021	125 022	125 023	125 024	125 031

ART	A	B	SP2	HT (standard)	BAR max: (standard)	DECKEL type:	DICHTUNG code:	KG (standard)
381	225	175	1	130	1,0	CN	120 613	4,0

-  **rechteckige Putztür, Aussenöffnung**
-  **RECTANGULAR manwaydoor outwards opening**
-  **Porte rectangulaire avec ouverture à l'extérieur**
-  **Puerta rectangular de apertura externa**
-  **PORTELLA RETTANGOLARE apertura esterna**
-  **ПРЯМОУГОЛЬНАЯ КРЫШКА с внешним открытием**





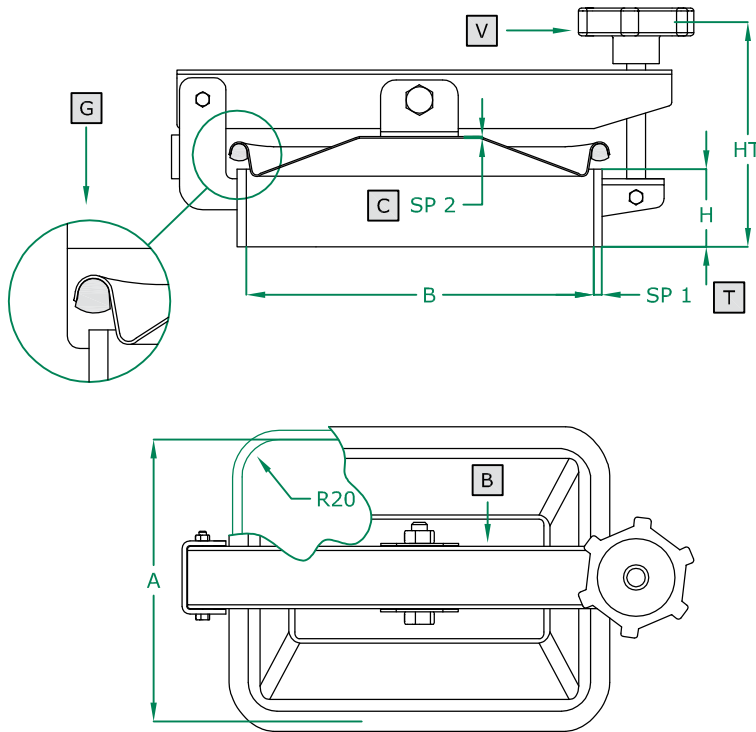

381L ART
175 X 225 mm

Deckel cover
G
Kragen frame
T
Hebelarm lever
B
Handrad handwheel
V
Dichtung gasket
G



	STANDARD		OPTIONAL			
H X SP1	50 X 6		30 X 6		100 X 6	
RAHMEN	SAT			MPL		
DICHTUNG	PARA	EPDM	NEOPRENE	NBR	SILICONE	VITON
HANDRAD	125 001 V	125 021	125 022	125 023	125 024	125 031

ART	A	B	SP2	HT (standard)	BAR max: (standard)	DECKEL type:	DICHTUNG code:	KG (standard)
381L	175	225	1	130	1,0	CN	120 613	4,0

-  rechteckige Putztür, Aussenöffnung
-  RECTANGULAR manwaydoor outwards opening
-  Porte rectangulaire avec ouverture à l'extérieur
-  Puerta rectangular de apertura externa
-  PORTELLA RETTANGOLARE apertura esterna
-  ПРЯМОУГОЛЬНАЯ КРЫШКА с внешним открытием





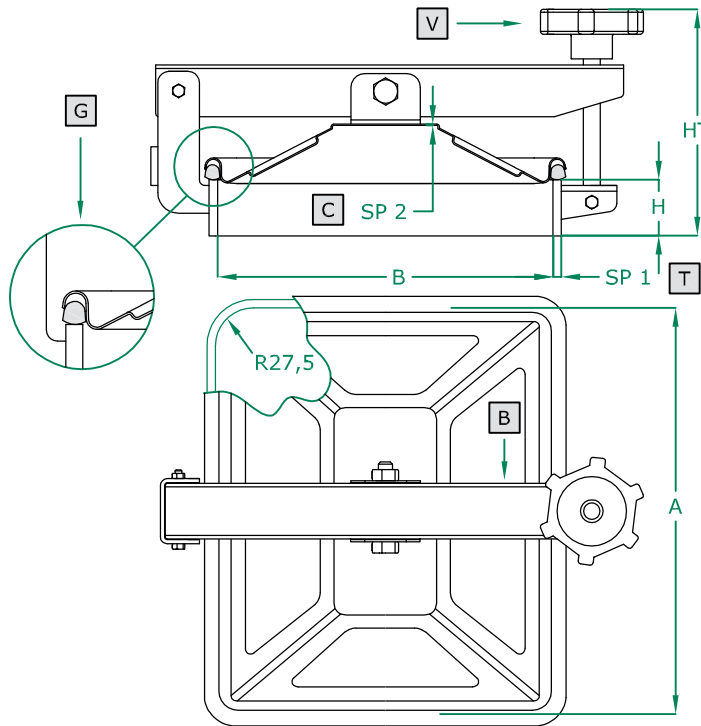

382 ART
310 X 245 mm

Deckel cover
C
Kragen frame
T
Hebelarm lever
B
Handrad handwheel
V
Dichtung gasket
G



	STANDARD		OPTIONAL			
H X SP1	50 X 6		30 X 6		100 X 6	
RAHMEN	SAT		MPL			
DICHTUNG	PARA	EPDM	NEOPRENE	NBR	SILICONE	VITON
HANDRAD	125 001 V	125 021	125 022	125 023	125 024	125 031

ART	A	B	SP2	HT (standard)	BAR max: (standard)	DECKEL type:	DICHTUNG code:	KG (standard)
382	310	245	1,2	145	1,0	CN	120 615	6,0

-  **rechteckige Putztür, Aussenöffnung**
-  **RECTANGULAR manwaydoor outwards opening**
-  **Porte rectangulaire avec ouverture à l'extérieur**
-  **Puerta rectangular de apertura externa**
-  **PORTELLA RETTANGOLARE apertura esterna**
-  **ПРЯМОУГОЛЬНАЯ КРЫШКА с внешним открытием**

382L ART
245 X 310 mm

Deckel cover	C
Rahmen frame	T
Hebelarm lever	B
Handrad handwheel	V
Dichtung gasket	G

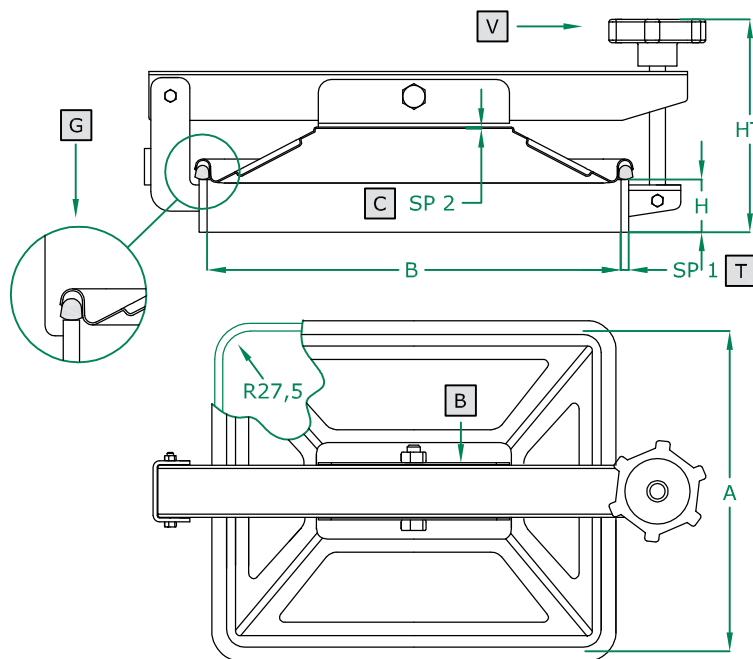

	STANDARD		OPTIONAL			
H X SP1	50 X 6		30 X 6		100 X 6	
RAHMEN	SAT			MPL		
DICHTUNG	PARA	EPDM	NEOPRENE	NBR	SILICONE	VITON
HANDRAD	125 001 V	125 021	125 022	125 023	125 024	125 031

ART	A	B	SP2	HT (standard)	BAR max: (standard)	DECKEL type:	DICHTUNG code:	KG (standard)
382L	245	310	1,2	145	1,0	CN	120 615	6,0